

Steel X ATEX

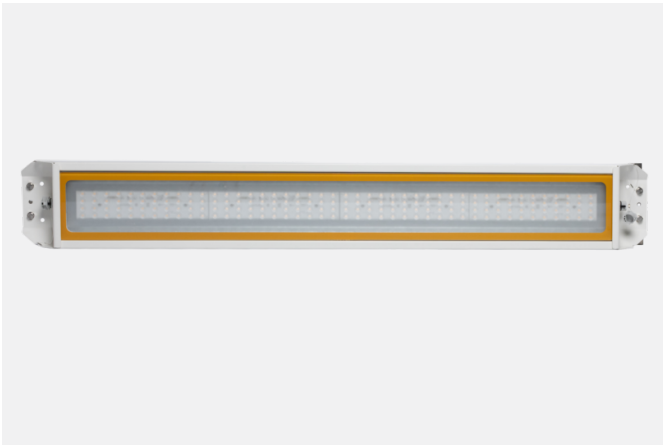

STXS, Z2, 40, Y4403, DGM, 840

Product ID	STXSZ240Y4403DGM840
EPD available	No
Certificates	ATEX
MinTa in °C	-20
MaxTa in °C	40
IP rating	IP65
IK rating	IK10
Corrosion class	C5-M
Electrical class	Class I, Class II
Voltage range (V)	220 - 240
Frequency range (Hz)	50 - 60
Total power consumption (W)	40
Power factor	0.95
PstLM	<1
SVM	<0.4
THD	<8
Driver type	On/Off, DALI2
Dimming capability	No dimming, DALI2
Driver options	Luxtronic
Number of drivers	1
Luminous flux from luminaire (lm)	5600
Efficacy (lm/W)	140
Color temperature (K)	4000
CRI (Color Rendering Index)	80
McAdam steps	3
Optic type	Symmetric 89°
Optic code	Y4403
Energy class of light source	D
LED lifetime L90B10 Ta25 (h)	50000
LED lifetime L80B10 Ta25 (h)	100000
Luminous flux decline (LLMF) 50.000h Ta25	L90

Steel X ATEX

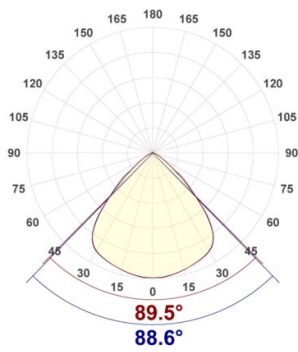
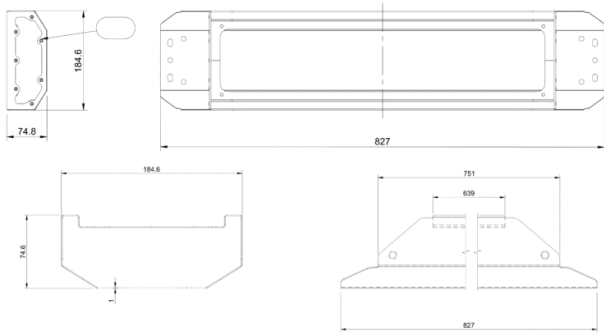

Warranty period	5 years
Main housing material	Stainless Steel 316L
Housing color code / name	White
Finish / Coating type	Powder coating
Diffuser design	Frosted
Product Mounting	ceiling surface, wall surface
Cable type	Not included
Length (mm)	830
Width (mm)	185
Height (mm)	75
Net weight (kg)	5.7
Full product weight (kg)	6.7
Recommended installation height in m	5-6m

